

IST8210

Magnetic Angle Sensor

Datasheet

Table of Contents

1. GENERAL DESCRIPTION	3
2. CIRCUIT DIAGRAM, OUTPUT SIGNAL, PACKAGE DIMENSION AND PIN DESCRIPTIONS	4
2.1. Circuit Diagram	4
2.2. Output Signal	4
2.3. Package Dimensions	5
2.4. Pin Descriptions	6
2.5. Marking Information	7
3. ELECTRICAL AND MAGNETIC SPECIFICATIONS	7
3.1. Absolute Maximum Ratings	7
3.2. Recommended Operating Conditions	7
4. TECHNOLOGY OVERVIEW	8
4.1. AMR Technology	8
4.2. Advantages of AMR Technology	8
4.3. Features of IST8210	9
4.4. Advantages of IST8210	9
5. ORDERING INFORMATION	10
6. LEGAL DISCLAIMER	10
6.1. Warranty and Liability Disclaimer	10
6.2. Application Disclaimer	10
6.3. Disclaimer Regarding Changes	11

1. General Description

iSentek IST8210 is a magnetic angle sensor with dimensions of $3.8 \times 4.9 \times 1.75 \text{ mm}^3$ in 8-pin SO8-packaging and $2.0 \times 2.0 \times 0.75 \text{ mm}^3$ in DFN-packaging. The sensor comprises two independent full Wheatstone bridges that are built based on anisotropic magnetoresistance (AMR) effect.

The sensor detects the direction of rotating magnetic field in the sensor plane and generates two sinusoidal output signals that reflect the angle θ between the sensor and magnetic field direction. $\text{Sin}(2\theta)$ and $\text{Cos}(2\theta)$ are the functions corresponding to the two outputs of the rotating field.

Features

- Based on anisotropic magnetoresistance (AMR) technology
- Built by a pair of independent full Wheatstone Bridges, generating output in sine and cosine wave form simultaneously
- Wide range of working temperature from $-40 \text{ }^\circ\text{C}$ to $+150 \text{ }^\circ\text{C}$

Advantages

- Non-contact and wear-free angle measurement
- Insensitive to dust, water, oil, or other contamination
- Excellent robustness against shocks and vibrations
- Constant sensitivity in harsh operation fields
- Allowing large working spacing
- High sensitivity
- Excellent precision even with weak operation magnetic field
- Negligible hysteresis effect
- Minimal output offset level
- RoHS, HF and TSCA compliant

Applications

- Incremental or absolute position detection for linear or rotational motion
- Travel measurements
- Incremental or absolute angular gauges
- Motor communication
- Rotational speed measurements
- Angle measurement (180° absolute)
- Industrial robotics
- Valve controllers

- Power tools
- Automatic applications

2. Circuit Diagram, Output Signal, Package Dimension and Pin

Descriptions

2.1. Circuit Diagram

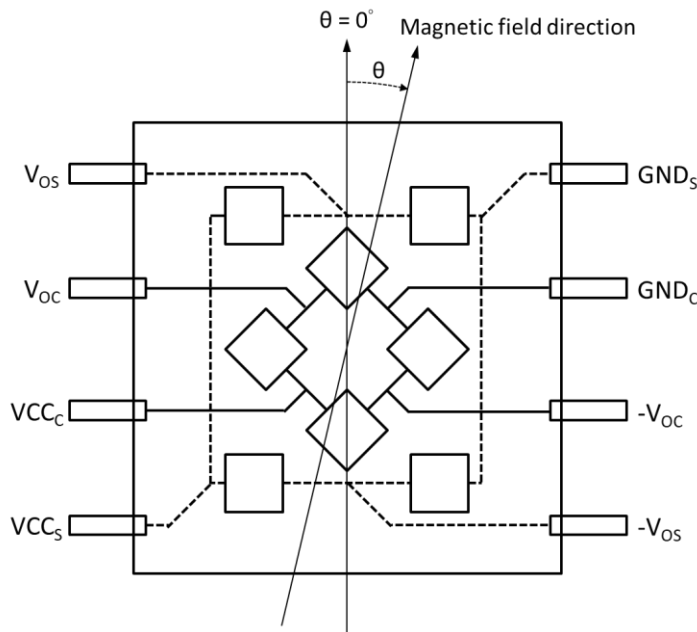

Fig. 1 Circuit diagram and definition of magnetic field direction.

2.2. Output Signal

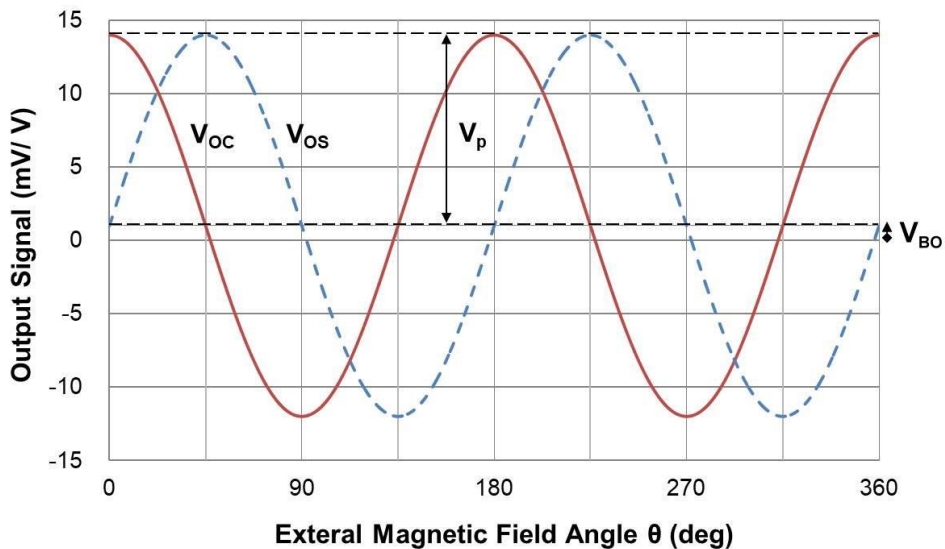
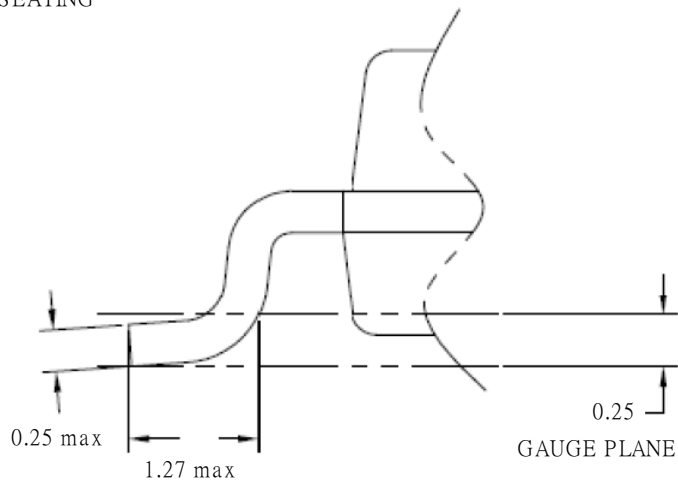
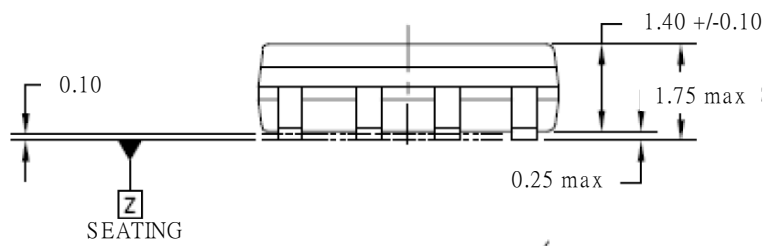
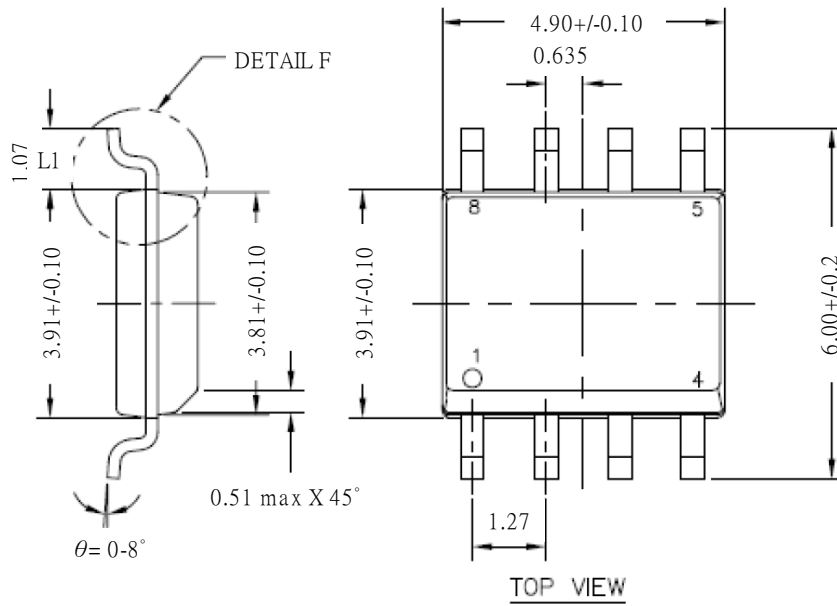

Fig. 2 Sensor output as a function of the angle θ

2.3. Package Dimensions

8-pin SO8-packaging



ROTATED 90° CCW
SCALE: 30/1

Unit: mm

8-pin DFN-packaging

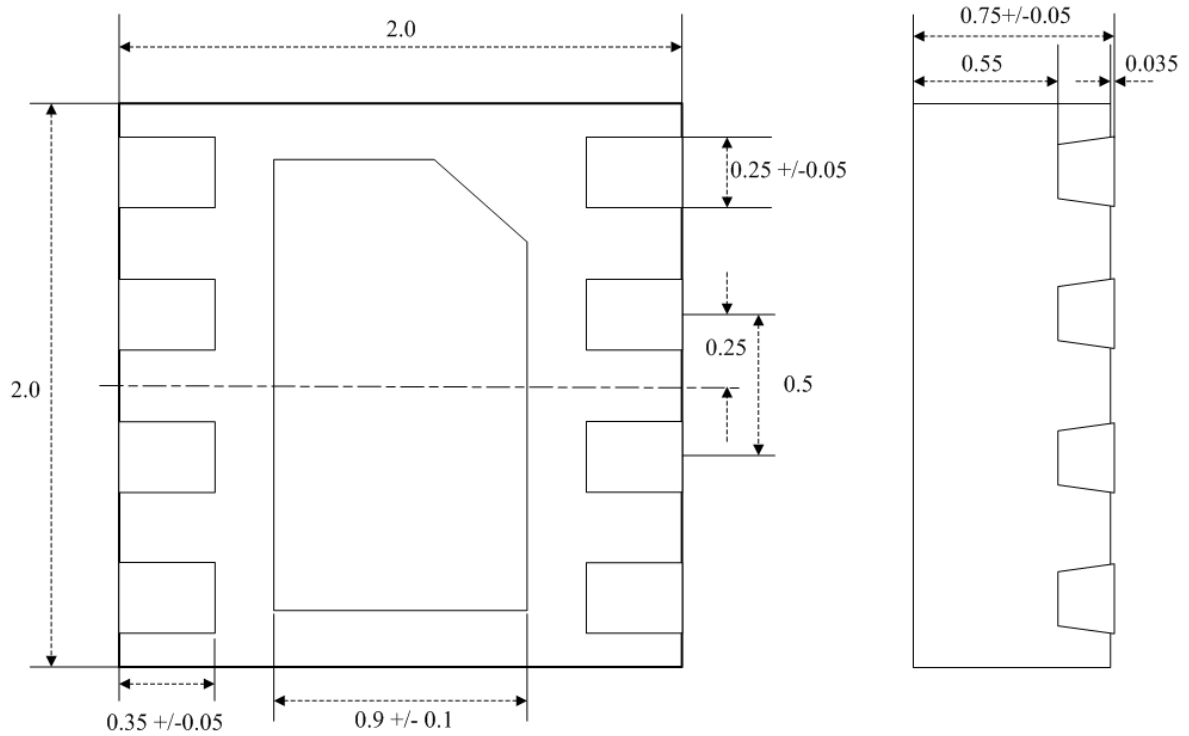

Unit: mm

Fig. 3 Package dimensions.

2.4. Pin Descriptions

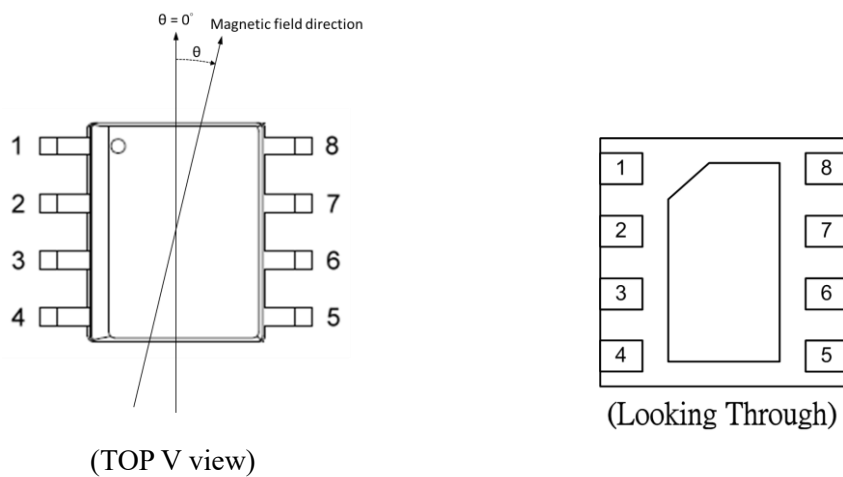

(TOP V view)

(Looking Through)

SO8 Packaging

DFN packaging

Pin *1	Name	Function
1	V _{OS}	Differential output voltage of sensing element S (Plus)
2	V _{OC}	Differential output voltage of sensing element C (Plus)
3	V _{CC}	Supply voltage of sensing element C

4	VCC _S	Supply voltage of sensing element S
5	-V _{OS}	Differential output voltage of sensing element S (Minus)
6	-V _{OC}	Differential output voltage of sensing element C (Minus)
7	GND _C	Ground of sensing element C
8	GND _S	Ground of sensing element S

*1 Please refer to Figure 4 on page 6.

2.5. Marking Information

Product code 8210

Date code X₁X₂X₃●

X₁: Year

X₂: Week

X₃: Week

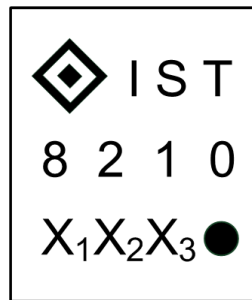

IST8210 TOP View
(SO8 Packaging)

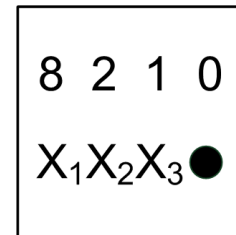

IST8210 TOP View
(DFN Packaging)

3. Electrical and Magnetic Specifications

3.1. Absolute Maximum Ratings

Parameter	Symbol	Limits	Unit
Storage temperature	TSTG	-40 and +150	°C
Supply voltage of sensing element S	VCC _S	±9	V
Supply voltage of sensing element C	VCC _C	±9	V
Floor life (≤ 30 °C/60% RH)	t _{FL}	1	year
Moisture sensitivity level	MSL	2	

3.2. Recommended Operating Conditions

Parameter	Symbol	Min.	Typ.	Max.	Unit
Operating temperature	T _O	-40		+150	°C
Operation magnetic field strength	H _{OP}		320*1		Gauss
Supply voltage of element S	VCC _S		5		V
Supply voltage of element C	VCC _C		5		V

*1 Should be higher than 320 Gauss.

4. Technology Overview

4.1. AMR Technology

IST8210 is a high-performance anisotropy magnetoresistance (AMR) angle sensor from iSentek. The AMR effect occurs in ferromagnetic (FM) materials, in which the electric resistance is a function of the angle between the directions of the magnetization of the FM material and electric current. When the magnetization is parallel to the current direction, a maximum resistance appears; when they are orthogonal, resistance reaches a minimum. The FM material used for IST8210 is Permalloy, which has excellent response to even the slightest external magnetic field change. iSentek's AMR sensors are manufactured in thin-film technology on a wafer. The production equipment, clean environment, and process steps are similar to those used in CMOS chip manufacturing.

4.2. Advantages of AMR Technology

AMR technology has following advantages:

- High sensitivity and low noise
- High resolution
- High bandwidth
- Small footprint
- Manufacturing process compatibility
- Excellent robustness
- Radiation resistant

The sensitivity of a sensing element based on AMR technology is approximately 50 to 200 times greater than that of a conventional Hall element. The high sensitivity and resolution enable exceptional performances, including high response speed, high accuracy, low noise, and low power consumption. Moreover, the manufacturing process is compatible with the CMOS process, allowing its integration into IC production. The small footprint of the AMR sensor makes it flexible in integrating with other sensors or devices. Compared to other sensing technologies like GMR and TMR, the simple layer structure of AMR (less than 3 layers depending on specific recipe) provides excellent robustness, especially against thermal-related impacts.

4.3. Features of IST8210

IST8210 contains two independent (galvanically isolated) full Wheatstone bridges arranged around the geometric center of the device. Each bridge generates sinusoidal output and solely responds to the direction of the external magnetic field. The output is generated from the resistance change of the AMR resistors as the external magnetic field changes direction. The two bridges form an angle of 45° , creating a phase shift in signal, so that the function of the output would be $\sin(2\theta)$ and $\cos(2\theta)$. The signal is provided via I2C bus. After arctangent conversion, the absolute angle is obtained.

Unique AMR resistors are the key to the IST8210's superior linearity and precision. Conventional AMR resistors are typically rectangular with long axis and short axes. The magnetization of the AMR resistors rotates in response to changes in the external magnetic field. Non-uniform shape anisotropy, however, causes a distribution in magnetic polarization with rotation angle, resulting in non-linear output. This issue is effectively resolved by the IST8210's innovative design, which achieves remarkable precision of 0.05° .

By combining a magnetic measuring scale with an evaluation circuit, IST8210 is able to precisely measure linear and rotary movements. IST8210 angle sensor is designed to be independent of the pole length (pitch) of the magnetic scale, providing maximum design flexibility..

4.4. Advantages of IST8210

IST8210 has many advantages including

- High accuracy and resolution
- Outstanding bandwidth and response speed
- Minimal bridge offset
- Low temperature coefficient of bridge offset
- Negligible magnetic hysteresis
- Non-contact and wear-free detection
- Allowing large working distance
- Insensitive to dust, water, oil, and other contamination
- Excellent robustness against shocks and vibrations
- Low power consumption
- Wide operation temperature range
- Constant sensitivity in extreme operation fields

The great performance of IST8210 provides accurate and instantaneous control of angle, position, travel, and sensitive speed. Even with a simple evaluation circuit, the minimal bridge offset voltage and negligible magnetic hysteresis of the sensor ensure measurement precision. The low temperature coefficient of both bridge offset and sensitivity allows operation across a broad temperature range without significant accuracy loss. The operation range from -40°C to 150°C covers many automotive applications. The non-contact nature avoids interference from the environment, such as dust, water, oil as well as from operation, such as wearing. IST8210 supports a large working distance, is resistant to shocks and vibrations, and offers flexibility for system integration in addition to excellent robustness. Distinct from conventional Hall angle sensors whose sensitivity is always proportional to the strength of the operation magnetic field, IST8210 has a constant sensitivity at an operation magnetic field that exceeds the suggested value. This unique feature allows end users to use magnets with a wide range of flux density without additional tuning of the evaluation circuits, which is usually necessary for Hall-based angle sensors.

5. Ordering Information

For more information on iSentek's magnetic sensors, please send an email to sales@isentek.com or visit our website at www.isentek.com.

6. Legal Disclaimer

6.1. Warranty and Liability Disclaimer

iSentek Inc. warrants the information in this datasheet. It is assumed that the specification is accurate and reliable. However, iSentek Inc. makes no warranties or claims regarding the accuracy or completeness of this information and takes no responsibility for the use of the information, nor does it convey any license under its patent rights or the rights of third parties.

iSentek Inc. shall not be liable for any consequential, incidental, indirect, or punitive damages (including, but not limited to, profit loss, business interruption, and further expenses related to the removal, replacement, or rework of any products).

6.2. Application Disclaimer

iSentek's products are unsuitable for life-critical and safety-critical applications. For the use of its products in such applications, iSentek disclaims all liability. The customer agrees to indemnify and hold iSentek harmless from and against all liabilities and losses.

6.3. Disclaimer Regarding Changes

iSentek reserves the right to modify the contents of this datasheet, including specifications and descriptions, at any time and without prior notice. This document supersedes all previously issued information.